

MANUAL

WORK LIGHT 15W (INC.WARNING LIGHT)

RED= +VDC (WORK LIGHT)

BLACK = (-)NEGATIVE

YELLOW= + WARNING LIGHT

(1 Flash pattern , Single flash) *Cable connection

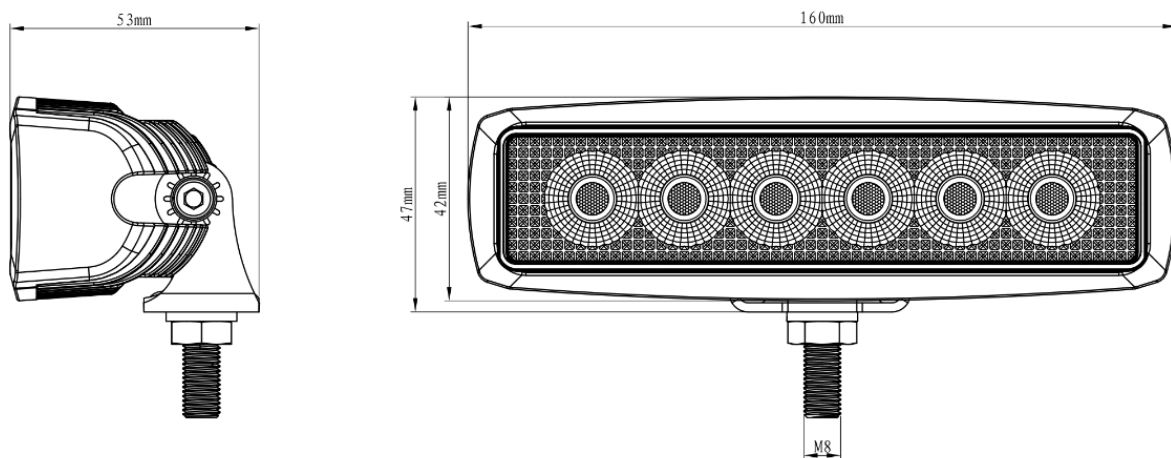

READ THIS BEFORE INSTALLATION

READ ALL INSTRUCTIONS AND STUDY DIAGRAMS BEFORE INSTALLING YOUR NEW LIGHTS!

LEGAL MOUNTING

Check with state or local authorities for laws governing usage and proper mounting of your new lights.

TAKE CARE OF YOUR PRODUCT

Keep the product clean. Dirt on the lens and heat-sink may shorten the products lifetime.

We recommend using lukewarm water and alkaline degreasing.

Follow the degreasing instructions carefully and rinse off gently with cold or lukewarm water on low pressure.

WARNING!

Strong chemicals should not be used on the product. If you accidently get strong chemicals on the product, rinse off immediately, use plenty of water so that no chemicals remain in any joint.

Some chemicals have a small amount of solvent in them, this can dissolve sealing adhesives and compromise the product's waterproofness.

Some chemicals pull out liquid from plastic and rubber-based components, which makes the plastic or rubber brittle and bursts more easily.

Be careful not to use high water pressure close up on the product. For products with breathers, ensure they are not damaged and take precautions to keep breather area clean.

If you use high water pressure at short distances, most products find it difficult to close out the water.

INSTALLATION

If there is a contact/connector on the product, it should not be cutted. If the connector is cut, the warranty is not valid.

If the product has loose cable and no connector. If the cable is shorter than 50 cm, the cable must not be cutted. If the cable is cut, the warranty is not valid.

If the cable is longer than 50 cm, it is ok to shorten the cable, but not shorter than 50 cm.

If the cable is cut shorter than 50 cm, the warranty is not valid.

Tighten screws and bolts so that they do not loosen or chafe.

Do not tighten screws so hard that the protective bearings on the product breaks.

WARNING!

Do not use higher volts than the product description states.

This light becomes hot under continuous use. Don't remove or touch the casing for at least 30 minutes after turning the lamp off.

If there is batch nr with sticker label on wire then it should not be removed otherwise warranty is not valid.